

01

**CAJA Y ESPIGA
EN ESQUINA CON COGOTE**

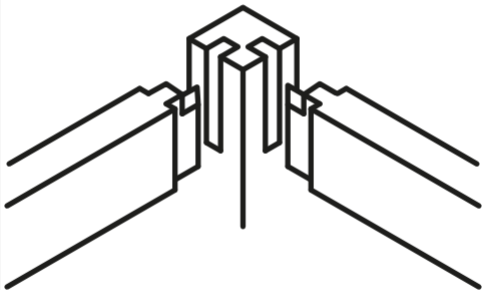

02

**CAJA Y ESPIGA
CON BARBILLA**

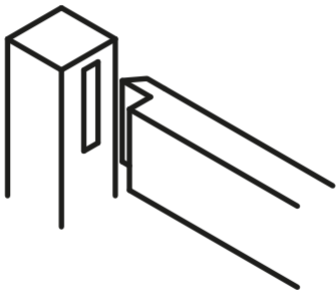

03

**CAJA Y ESPIGA
SESGADA**

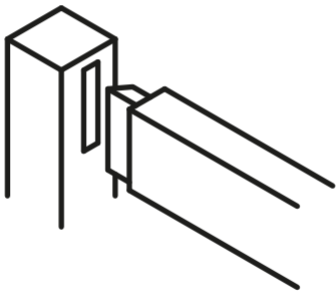

04

JUNTA A TOPE

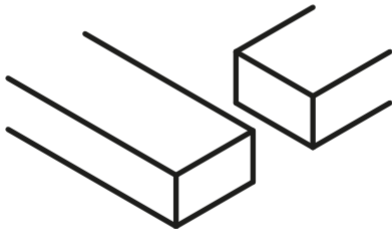

05

**UNIÓN A TOPE
EN INGLETE**

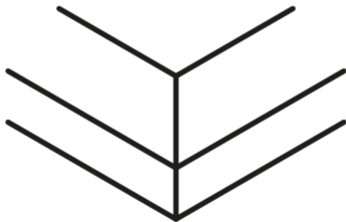

06

UNIÓN CON TARUGO

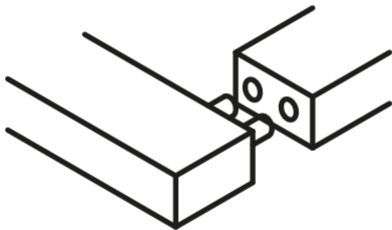

07

MEDIA MADERA

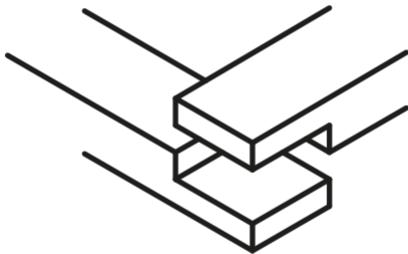

08

**UNION DE INGLETE
CON LENGUETA**

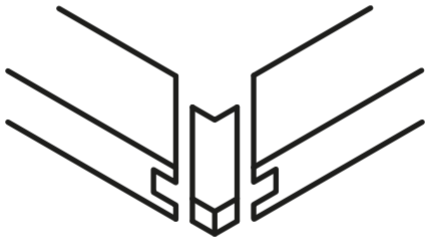

09

**UNION DE INGLETE
CON LENGUETA**

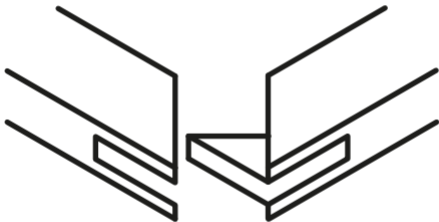

10

ESQUINA CON BRIDA

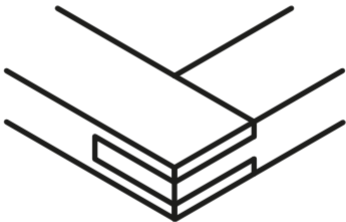

11

**BRIDA DE ESQUINA
EN INGLETE**

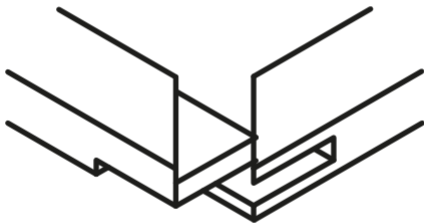

12

**BRIDA DE ESQUINA EN
INGLETE CON CUÑAS**

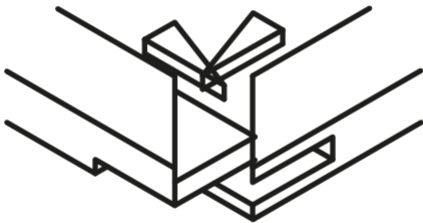

13

**CAJA Y ESPIGA
ACODADA**

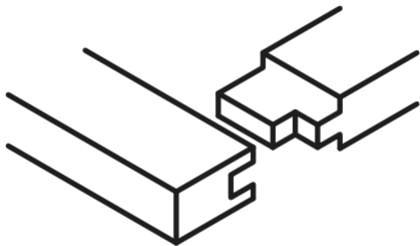

14

**CAJA Y ESPIGA CON
REBAJE**

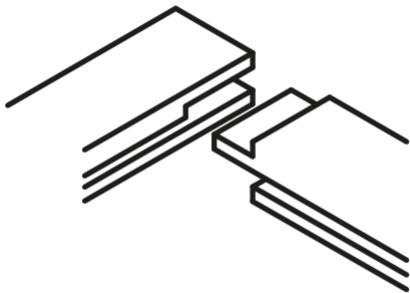

15

**CAJA Y ESPIGA
MARCO CON RANURA**

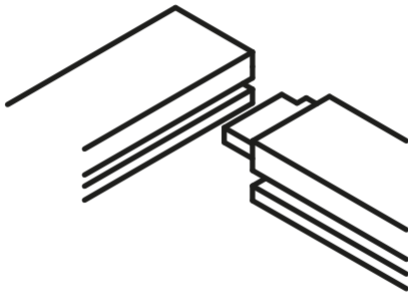

16

**CAJA Y ESPIGA
CON MOLDURA EN MARCO**

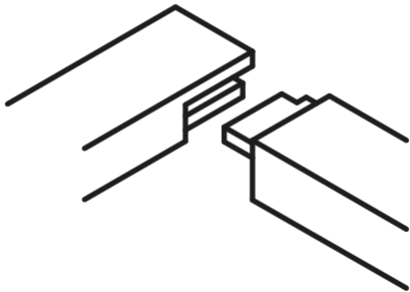

17

**CAJA Y ESPIGA
DOBLE**

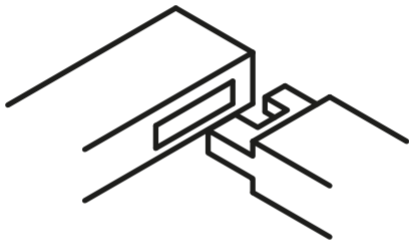

18

**CAJA Y ESPIGA
A FONDO**

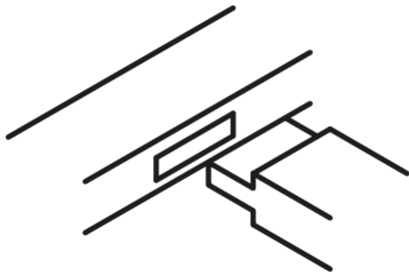

19

**CAJA Y ESPIGA
CON CUÑA**

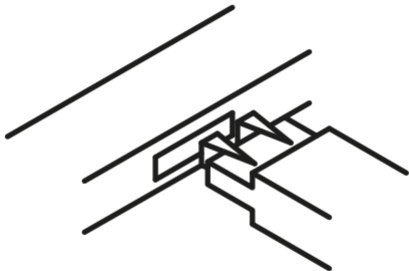

20

**CAJA Y ESPIGA
PASANTE**

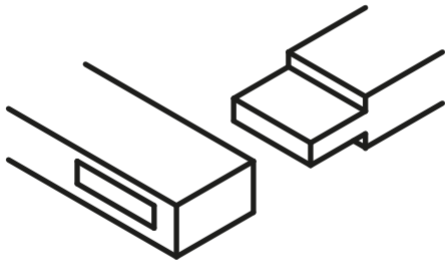

21

CAJA Y ESPIGA
MELLIZAS

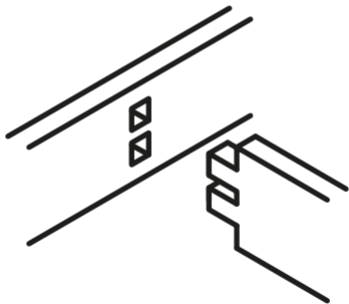

22

**CAJA Y ESPIGA
MELLIZAS**

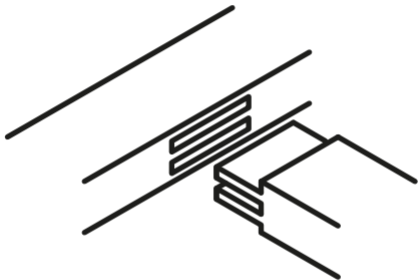

23

**CAJA Y ESPIGA
CON LLAVE**

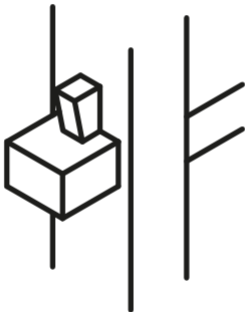

24

JUNTA A TOPE

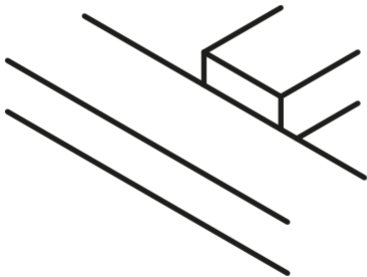

25

UNION T MEDIA MADERA

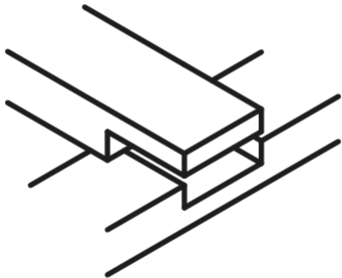

26

**T MEDIA MADERA
COLA DE PATO**

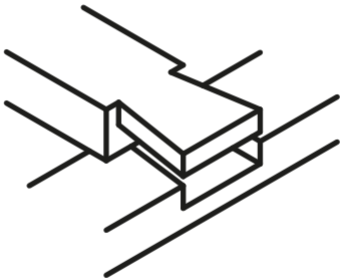

27

CRUZ MEDIA MADERA

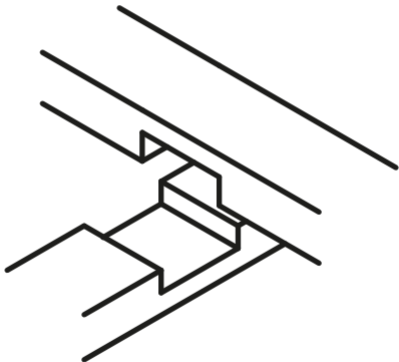

28

**CRUZ MEDIA MADERA
OBLICUA**

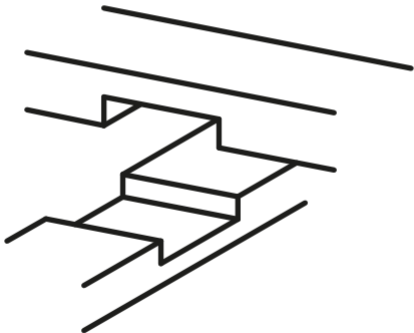

29

T CON BRIDA

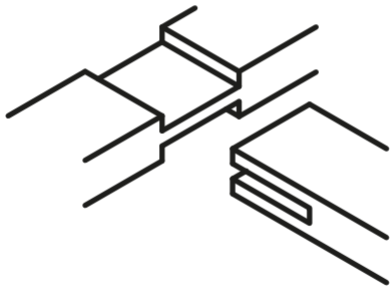

30

VIDRIO PARTIDO

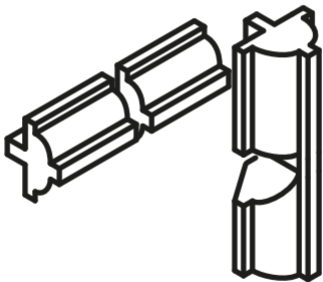

31

A TOPE

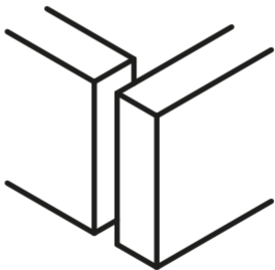

32

INGLETE

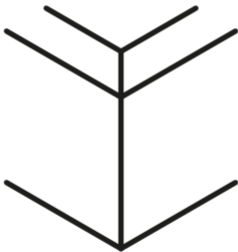

33

**MEDIA MADERA EN
ESQUINA**

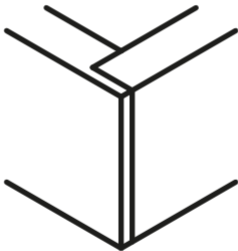

34

**MEDIA MADERA EN
ESQUINA INGLETE**

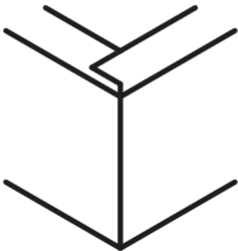

35

MEDIA MADERA TRABADA

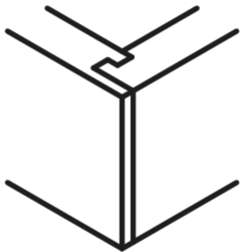

36

**INGLETE
TRABADO**

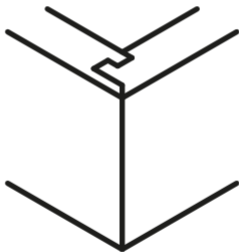

37

BARBILLA EMPOTRADA

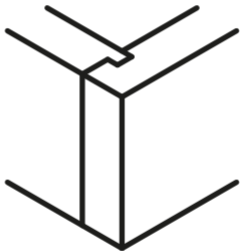

38

**JUNTA SOLAPADA
CON TARUGO**

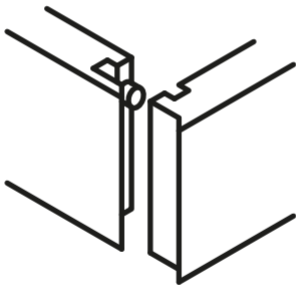

39

TARUGO A TOPE

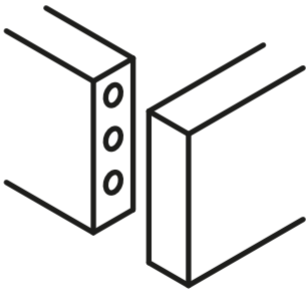

40

**A TOPE
CON ESQUINA**

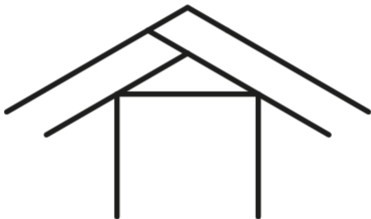

41

GALLETA

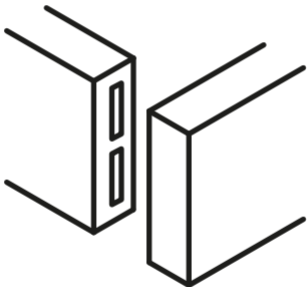

42

**INGLETE CON
RANURA**

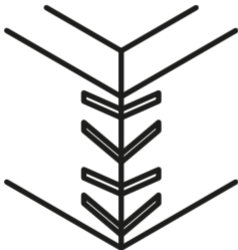

43

**INGLETE CON
GALLETA**

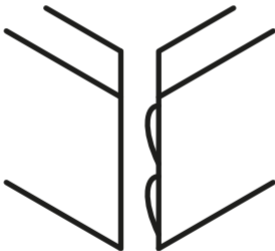

44

**INGLETE CON
TARUGO**

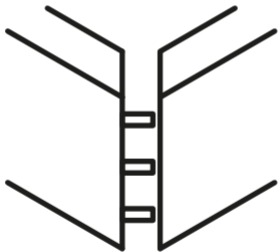

45

**INGLETE CON
LENGUETA**

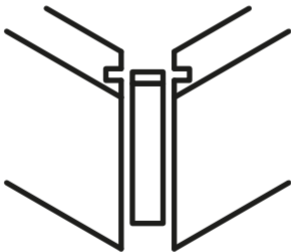

46

**FINGER JOIT/
MALLETADO**

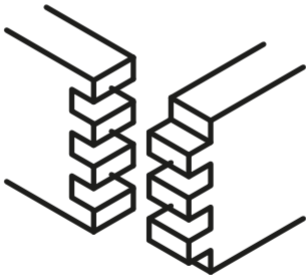

47

**MALLETADO CON
INGLETE**

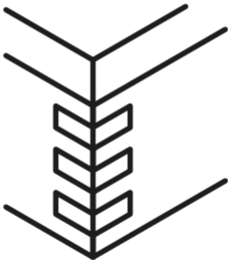

48

COLA DE MILANO

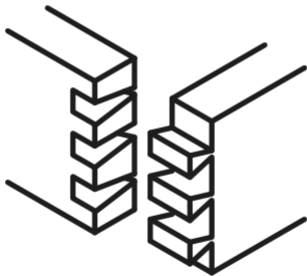

49

**UNION DE INGLETE
COLA DE MILANO**

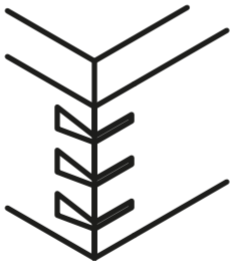

50

**COLA DE MILANO
ESCONDIDA**

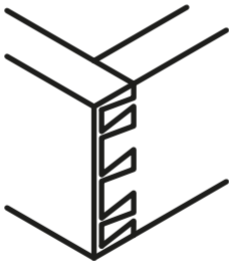

51

**DOBLE COLA DE
MILANO ESCONDIDA**

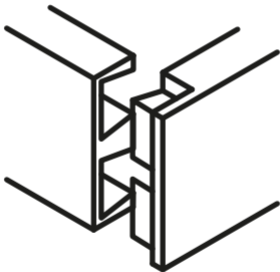

52

TABLA A TOPE

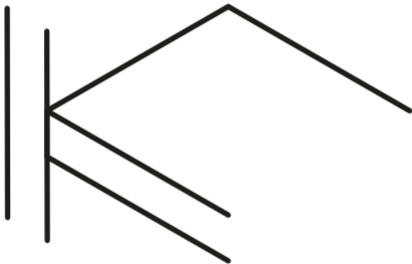

53

**TABLA CON
RANURA**

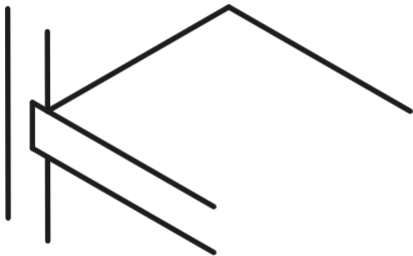

54

**TABLA CON
MILANO**

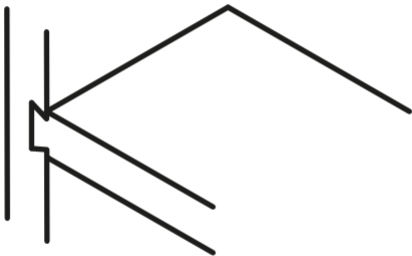

55

RANURA

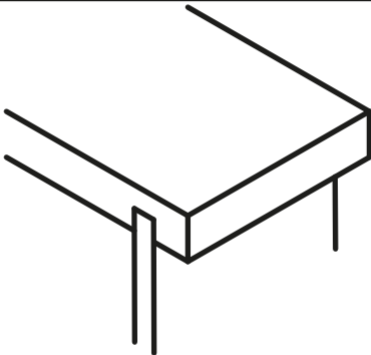

56

LISTONES A TOPE

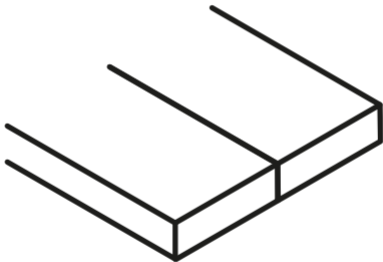

57

MEDIA MADERA

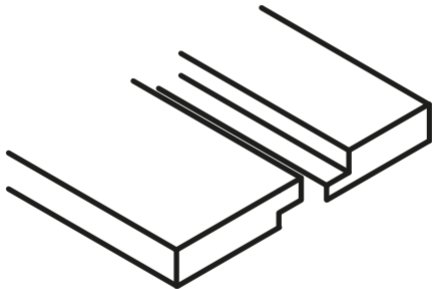

58

MACHIHEMBRADO

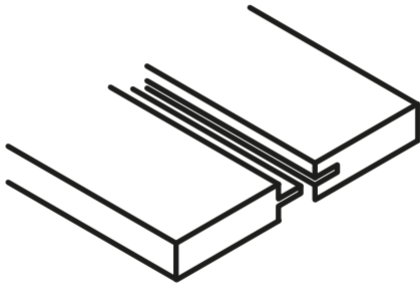

59

LENGUETA

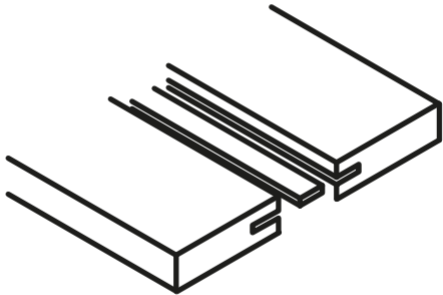

60

TARUGOS

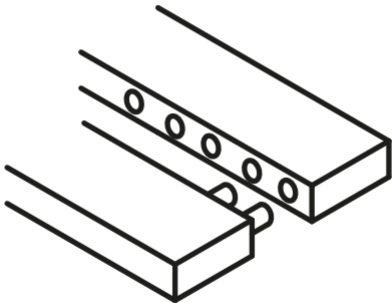

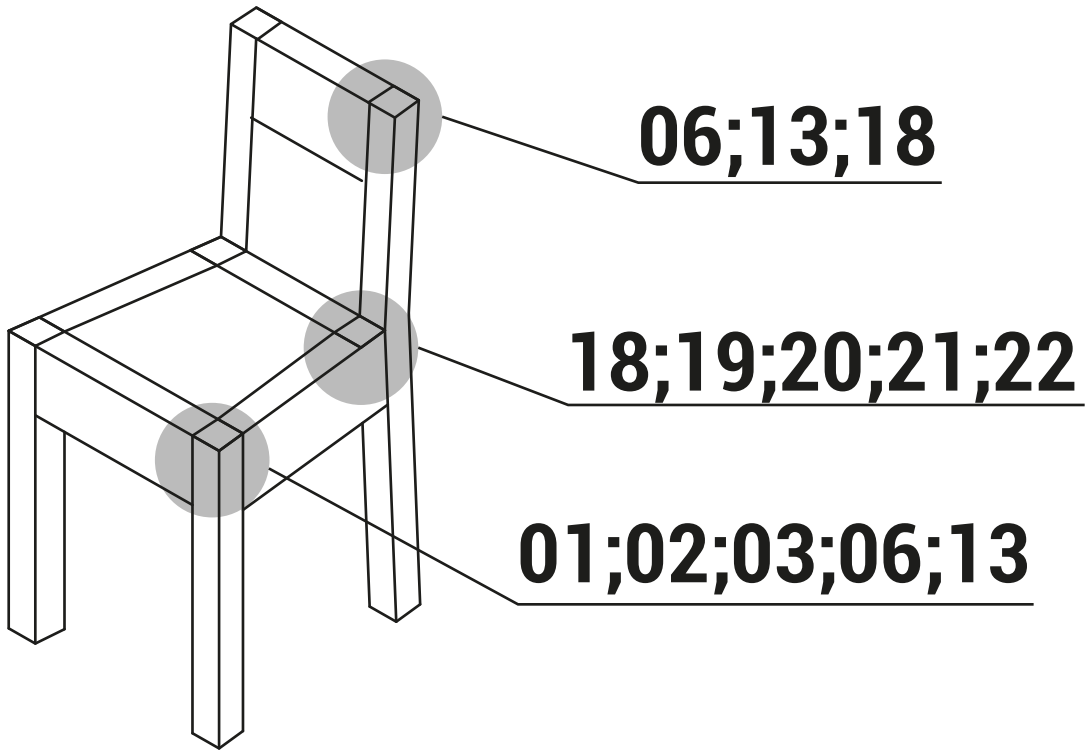

06;13;18

18;19;20;21;22

01;02;03;06;13

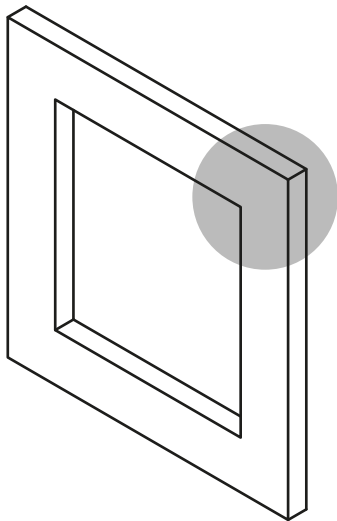

04; 05; 06; 07; 08;
09; 10; 11; 12; 13;
14; 15; 16

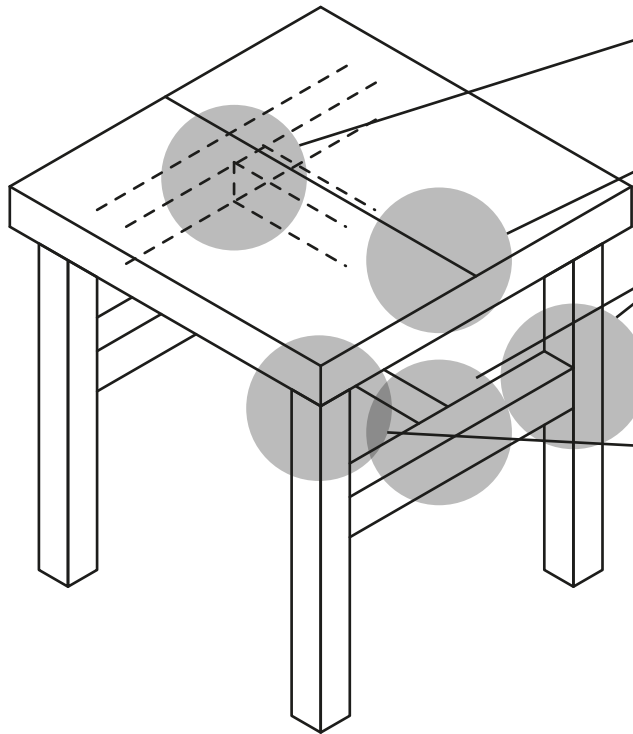

21; 22; 23; 24

56; 57; 58; 59; 60

**18; 19; 20; 21; 22;
23**

**01; 06; 10; 11; 13;
17**

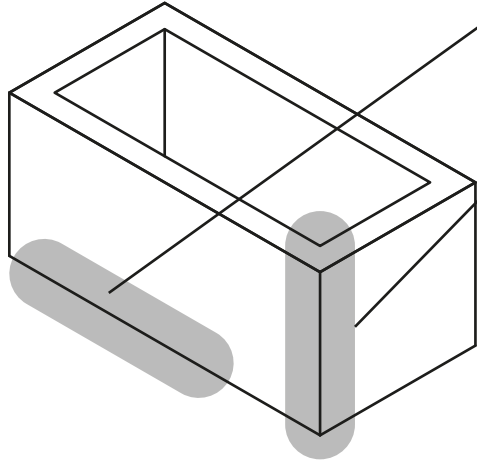

55

31; 32; 33; 34; 35;

36; 37; 38; 39; 40;

41; 42; 43; 44; 45;

46; 47; 48; 49; 50;

51

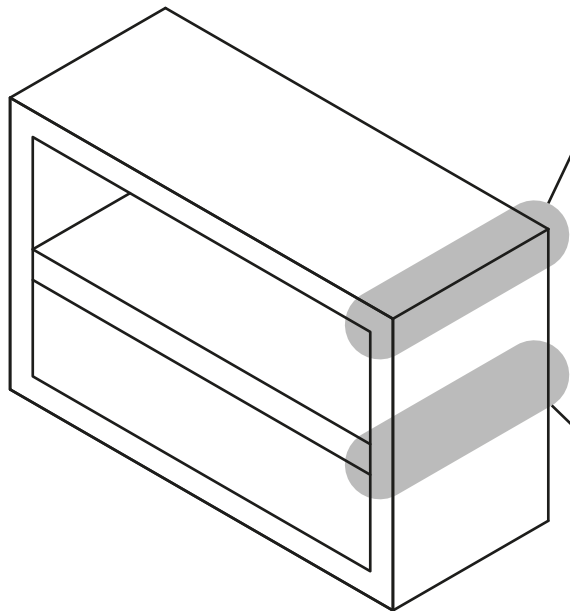

31; 32; 33; 34; 35;

36; 37; 38; 39; 40;

41; 42; 43; 44; 45;

46; 47; 48; 49; 50;

51

52; 53; 54